



AM



A&D



YM



DM

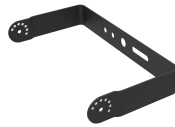

FM

P/N:ALS-S-GB-200WC30T3A1-abcdefg

Where "a" can be any two letters represent lamp colors; "BH = Black、WH=White、BR=Brown or Customized"

"b" can be "3RP", "3NP", "5RP", "5NP", "7RP" or "7NP" for Photocontrol type provided or blank for no Photocontrol provided;

"c" can be "10SP" or "20SP" for Surge-Protective Device type provided or blank for no Surge-Protective Device provided;

"d" can be "PS" or "MS" for Motion Sensor type provided or blank for no Motion Sensor provided;

"e" can be "AM", "DM", "YM", "A&D" or "FM" to represent mounting bracket types;

"f" can be "S" or blank for Socket provided or not;

"g" can be any two digits to represent CCT.

DIMENSIONS

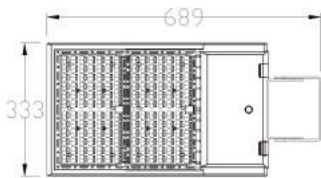

YM

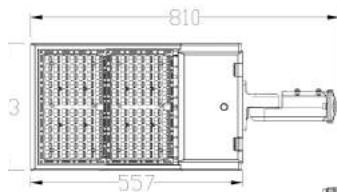

A&D

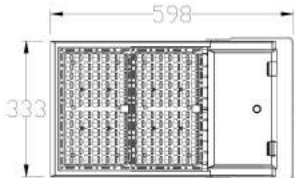

FM

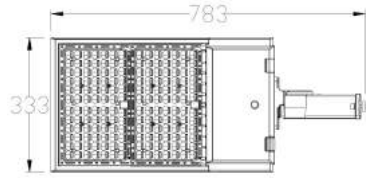

DM

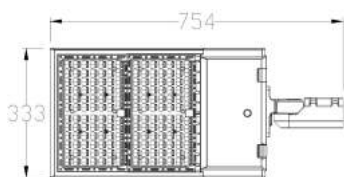

ADVANTAGE

- UL certificate.
- Seoul Chip, high CRI.
- China Brand IP65 driver, input voltage 100-277VAC.
- Output constant current lever can be adjusted through output cable with 1-10V.
- No UV or IR in the beam.
- Easy to install and operate.
- Energy saving, long lifespan.
- Light is soft and uniform, safe to eyes.
- Instant start, NO flickering, NO humming.
- Green and eco-friendly without mercury.

APPLICATION

- Outdoor basketball court, tennis court.
- Badminton court, the football field.
- The school playground, stadium.
- Community leisure entertainment plaza, road lamp etc.

AM

SPECIFICATIONS

OPTICAL	Input Power	200W
	Lumen	26000-29000LM
	Lumen Efficacy	130-145 LM/W
	Color Temperature	4000K, 5000K, 5700K
	CRI	>70
	Viewing Angle	140*50 Degree (Type III)
ELECTRICAL	Input Voltage	100-277VAC 50/60Hz
	PF	≥0.9
	THD	≤20%
	Driver Model	China Brand Driver SS-200VA-56B
	Optional Accessory	Photocell / Surge protector/ Motion sensor/Socket
MATERIALS	LED Brand	SEOUL
	LED Type	SMD3030
	LED QTY	308 PCS
	Housing	Aluminum Alloy
	Housing Color	Black / Brown/white/Customized
	Waterproof Rating	WET (IP65)
OTHERS	Operating Temperature	-40°C TO 50°C
	Operating Humidity	10%-90% RH
	Storage Temperature	-40°C TO 80°C
	Storage Humidity	10%-95% RH
	Warranty Time	5 Years

PACKAGE

Stent Type	Lamps Net Weight	Size	Qty/ Carton	Weight/ Carton
AM	8.24KG	840*385*155mm	1	9.3KG
DM	8.72KG	840*385*155mm	1	10 KG
YM	8.76KG	840*385*155mm	1	10KG
A&D	9KG	840*385*155mm	1	10.3KG
FM	7.76KG	730*400*155MM	1	9KG

LIGHT DISTRIBUTION TESTING PARAMETERS

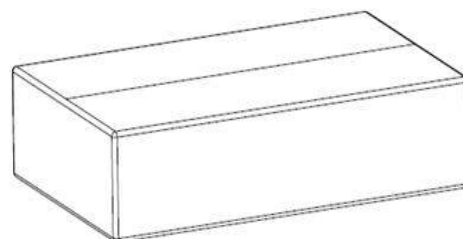
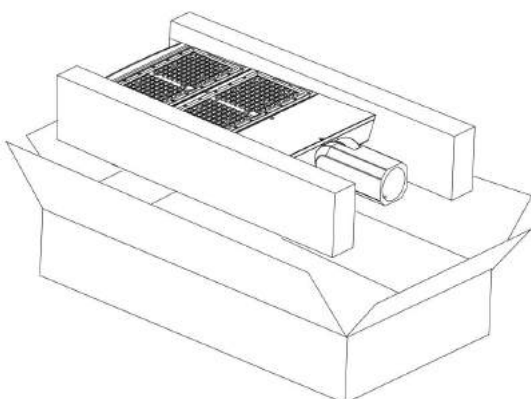

Luminaire Manufacturer:

Voltage: 119.1 V

Power: 201.46 W

Current: 1.696 A

Power Factor: 0.997

Photometric Results

IES Classification: Type III

Total Rated Lamp Lumens: 28075.0 lm

Efficiency: 100%

Upward Ratio: 1%

Central Intensity: 233.62 cd/klm

Pos of Max. Intensity: H170 V70

Longitudinal Classification: Medium

Measurement Flux: 28075 lm

Downward Ratio: 99%

Luminaire Efficacy Rating (LER): 139.41

Max. Intensity: 354.05 cd/klm

Luminous Intensity Distribution Curve

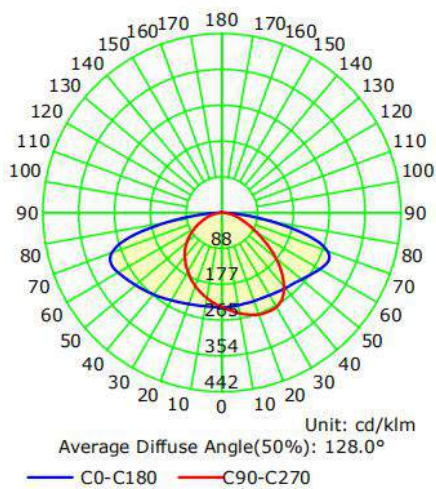

Illuminance at a Distance

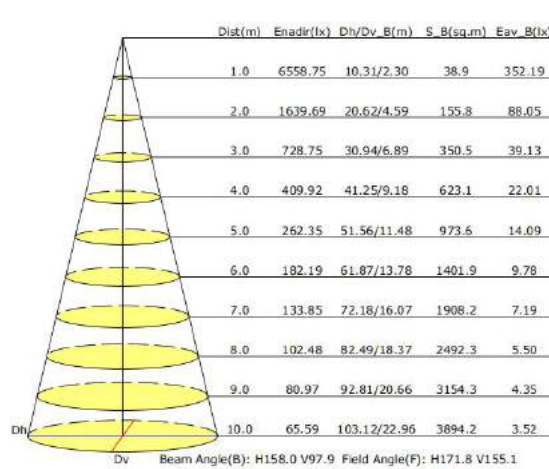

NOTICE FOR USER

- Please turn off power before install or change assembly parts.
- The input voltage and lamps should be matched, after connecting the power line, Please make sure the wiring section is insulated.
- No-professionals, must not install and disassemble the lamps.

TROUBLE SHOOTINGS

Troubles	Check points
Flickering of the light	Turn off the power and turn on again in 3 minutes. If same phenomena occur, then call agencies.
Out of working	Please check the connection.